

Part number

MAV 24.40



Brief description:

hoods for two levers, size "104.27", top entry, M40, metal version, IP66

Product description

Version	metal version
Series	hoods for two levers
Product type	with 4 pegs
Variant	top entry
Style	high construction
Family	CLASS enclosures
Size	size "104.27"

Technical data

Material	metal
IP degree of protection	IP66 (and IP69K DIN 40050 - 9)
Cable entry	M40

Further technical details

Weight	240,00 g
--------	----------

Approvals / Standards

Quality mark	 (type:4/4X/12),  , EAC
Conformity	CQC, CE

General ordering information

EAN13 code	8015747052887
Tariff number	85369095

Packaging Information

Packaging length	240,00 mm
Packaging height	150,00 mm
Packaging width	195,00 mm
Packaging weight	2,40 kg
Packaging volume	7,02 dm ³
Packaging description	Carton box
Packaging quantity	10 Pcs
Packaging EAN code	8015747052894
Sub-packaging weight	1,20 kg
Sub-packaging description	Plastic packaging
Sub-packaging quantity	5 Pcs
Sub-packaging EAN barcode	8015747052900

Part number

MAV 24.40



Catalogue drawings

**CHO [CAO] CHV (CAV) - MHO [MAO]
MHV (MAV)**

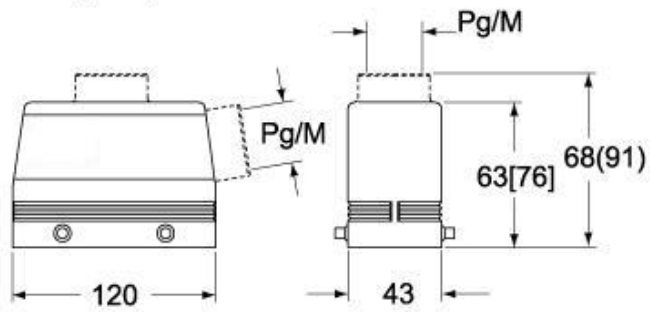

CHV G (CAV G) - MHV G (MAV G) - [MFV G]

